



2011-16 FORD SUPER DUTY INSTALLATION INSTRUCTIONS

Thank you for purchasing this set of two ROCKSTAR™ Splash Guard Mud Flaps. Agri-Cover, Inc. proudly manufactured these mud flaps using superior quality materials and workmanship. With proper care, your mud flaps will provide years of service and enjoyment.

NOTICE TO INSTALLER: Even if familiar with mud flaps, read instructions prior to installation as improvements may be made without notice. Always handle components with care. If you have questions or problems, call customer service. When done, these instructions must be given to the consumer.

NOTICE TO CONSUMER: Before using this product, read safety and maintenance section of these instructions. Save these instructions for future reference.

FOR YOUR RECORDS

DATE PURCHASED: _____

WHERE PURCHASED: _____



Questions? 888-568-3709
agricover.com

PREPARATION

Unpack set of two mud flaps with components. Clean vehicle wheel wells. For additional installation assistance, go to rockstarmudflaps.com for install video.

MUD FLAP COMPONENTS

- (2) Mud flaps
- (2) #10 x 1-1/4" Self-drilling hex screw
- (6) #10 x 1/2" Washers
- (4) 7 mm screws (front only)
- (4) 10-24 x 1-1/2" Truss head screws (rear only)
- (2) Stabilizing brackets (rear only)
- (2) 5/16" x 1" Hex bolts (rear only)
- (4) 5/16" Washers (rear only)
- (2) 5/16" Lock washers (rear only)
- (2) 5/16" Nuts (rear only)
- (2) #8-32 Nylon nuts (rear only)
- (4) 10-24 Nuts (rear only)

TOOLS NEEDED

- Angled drill/screwdriver
- Phillips head, 7 mm, 5.5 mm and 5/16" sockets
- Protective eyewear

NOTE: Hardware components and appearance may vary.

⚠ CAUTION: These instructions involve drilling holes. Ensure all mounting hole sides are free of wiring, mechanical parts and are structurally sound.

PARTS & FASTENER MOUNTING DIAGRAM

NOTE: Mud flaps may be purchased with or without pre-installed trim plates (not pictured). Trim plates are also available for purchase as an accessory.

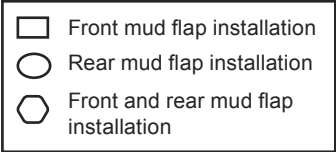
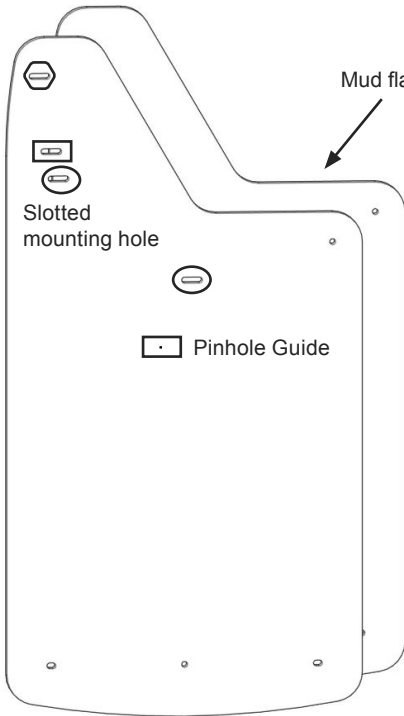

- Nylon hex nuts
- 5/16" Hex nuts
- 10-24 Nuts
- 5/16" Flat washers
- 5/16" Lock washers
- #10 Flat washers
- 10-24 x 1-1/2" Truss head screws
- 5/16" x 1" Hex bolts
- 7 mm Screws
- Self-drilling screws
- Stabilizing Brackets

1. PREPARING FOR INSTALLATION

A. Park on level ground with firm surface.

B. Check free space behind front tires when fully turned. Ensure enough space and clearance to accommodate 5/16" thick mud flaps.



NOTE: If trim plates are pre-installed, face them toward tailgate during installation.

C. To install mud flaps, perform one of the following:

- See Step 2 for front wheel well installation
- See Step 3 (page 6) for rear wheel well installation

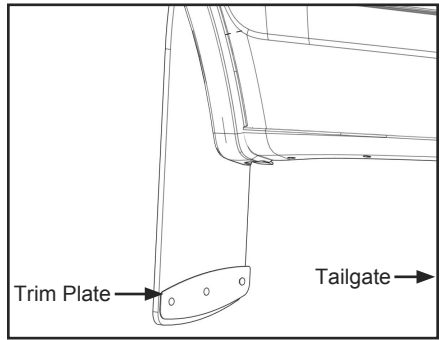

2. INSTALLING MUD FLAPS TO FRONT

NOTE: Front mud flap installation uses 3 holes per mud flap, see PARTS DIAGRAM (page 3) for locations.

A. Use 5.5 mm socket to remove lower factory mounting hardware indicated in adjacent image.

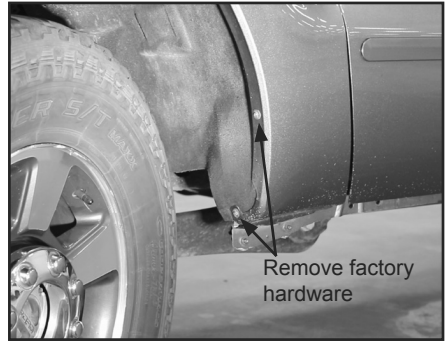

B. Install mud flaps with 7 mm screw through pinhole guide into lower free hole in wheel well. Leave loose for now.



C. Install 7 mm screw through 2nd slotted mounting hole into upper free hole in wheel well. Leave loose for now.



D. Level mud flap while adjusting placement to obtain best fit then tighten screws to hold in place.

E. Install a #10 x 1-1/4" self-drilling hex screw with flat washer at 1st slotted mounting hole.

F. Repeat for remaining front mud flap.



3. REAR MUD FLAP INSTALLATION

NOTE: Rear mud flap installation uses 3 mounting holes and 1 stabilizing bracket per mud flap, see PARTS DIAGRAM (page 3) for locations.

A. Locate lower mounting holes identified in adjacent image.

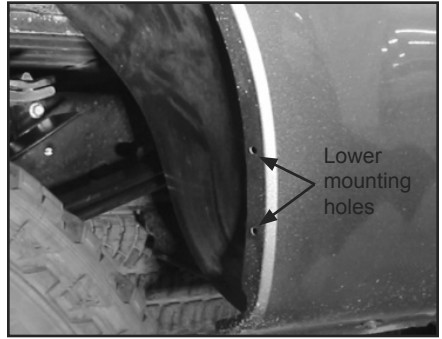

B. Install mud flaps with (2) 10-24 x 1-1/2" truss head screws with flat washers through 1st and 3rd slotted mounting holes into free holes in wheel well. Finger tighten nuts onto free ends of screws.

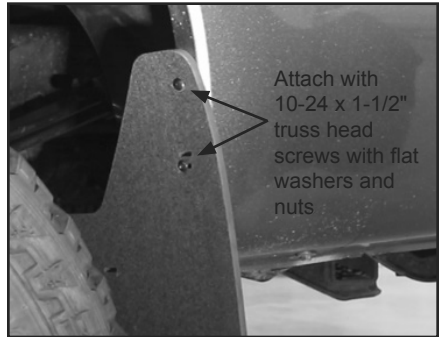

C. Level mud flap while adjusting placement to obtain best fit then secure truss head screws with nuts to hold in place.

D. From under truck, attach stabilizing bracket to existing hole in lower portion of rear quarter panel (adjacent to mud flap) with 5/16" x 1" hex bolt, lock washer, (2) flat washers and nut.

E. Attach bracket to rear of mud flap with #10 x 1-1/4" self-drilling hex screw, flat washers and nylon nut (see below). Ensure self-drilling screw attaches through 5th slotted mounting hole in mud flap (see next page).

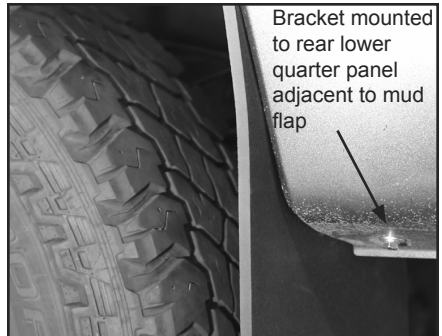
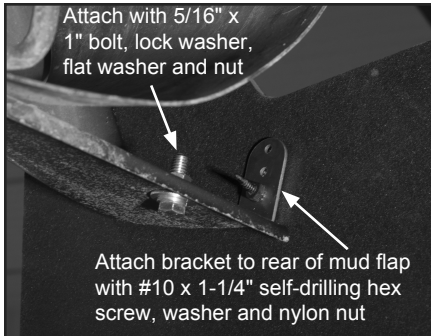

3. REAR MUD FLAP INSTALLATION (Continued)



F. Repeat for remaining rear mud flap.

SAFETY AND MAINTENANCE

The operator can perform most of inspection and maintenance. It may be necessary to review the installation instructions.

- Periodically check all screws, washers and nuts, retighten if needed.
- If mud flap has been damaged, replace with new one.

NOTE: Inspection and/or maintenance should be performed anytime a malfunction is observed or suspected. If you need assistance inspecting and/or servicing your mud flaps, call customer service at 888-568-3709. Always use original equipment replacement parts for your mud flaps.

MANUFACTURER'S LIMITED WARRANTY

Agri-Cover, Inc. extends the following (1) year Limited Warranty for the ROCKSTAR™ Splash Guard Mud Flaps:

Agri-Cover, Inc. warrants a period of one (1) year from the date of manufacture that its ROCKSTAR™ Splash Guard Mud Flaps are free from defects in workmanship, under normal use for the truck model it was intended for. This Limited Warranty does not cover any damage due to accident, abuse, misuse, alteration, neglect, improper installation, or ordinary wear and tear.

Agri-Cover, Inc.'s sole obligation under this Limited Warranty is limited to the repair or replacement at its option, of defective parts only. No labor or service allowance is given or implied. IN NO EVENT SHALL AGRI-COVER, INC. BE LIABLE FOR INCIDENTAL, CONSEQUENTIAL, OR SPECIAL DAMAGES. AGRI-COVER, INC. EXPRESSLY DISCLAIMS ANY AND ALL IMPLIED WARRANTIES OF MERCHANTABILITY, AND THERE ARE NO WARRANTIES WHICH EXTEND BEYOND THE LIMITED WARRANTY DESCRIPTION CONTAINED HEREIN.

For warranty, have serial number ready and fill out the warranty claim form at agricover.com/warrantyclaim or call Customer Service Department at 888-568-3709 to determine if only a replacement part is needed or if the mud flaps needs to be returned for inspection and repair. Goods to be returned must have a pre-authorized RA # (Return Authorization Number) - obtained by calling the number above. Mark the number on the package and ship it freight prepaid to address below. Agri-Cover, Inc. will pay freight to return goods to sender.

This Limited Warranty gives you specific legal rights and you may have other rights, which vary, from state to state.

For replacement parts shop at rockstarmudflaps.com or call Customer Service at 888-568-3709.



Agri-Cover, Inc.
Customer Service Dept
3000 Hwy 281 SE
Jamestown, ND 58401
Phone: 888-568-3709

Hours: 8:00 am - 5:00 pm CST Monday through Friday, except Holidays