



21-ON FORD F-150 INSTALLATION INSTRUCTIONS

Thank you for purchasing this set of two ROCKSTAR™ Splash Guard Mud Flaps. Agri-Cover, Inc. proudly manufactured these mud flaps using superior quality materials and workmanship. With proper care, your mud flaps will provide years of service and enjoyment.

NOTICE TO INSTALLER: Even if familiar with mud flaps, read instructions prior to installation as improvements may be made without notice. Always handle components with care. If you have questions or problems, call customer service. When done, these instructions must be given to the consumer.

NOTICE TO CONSUMER: Before using this product, read safety and maintenance section of these instructions. Save these instructions for future reference.

FOR YOUR RECORDS

DATE PURCHASED: _____

WHERE PURCHASED: _____



Questions? 888-568-3709
agricover.com

PREPARATION

Unpack set of two mud flaps with components. Clean vehicle wheel wells. For additional installation assistance, go to rockstarmudflaps.com for install video.

MUD FLAP COMPONENTS

- (2) Mud flaps
- (2) Nylon hex nuts
- (4) Serrated flange nuts (rear only)
- (2) 5/16" x 1" Allen button head bolts
- (2) #10 x 1-1/4" Self-drilling hex screws
- (4) #10 x 1-1/2" Truss head screws (rear only)
- (4) 7 mm Screws (front only)
- (2) Clinch brackets
- (2) Mud flap brackets

TOOLS NEEDED

- Ratchet/screwdriver
- 7 mm and 5/16" sockets
- #2 Phillips screwdriver
- 3/16" Hex key
- Protective eyewear





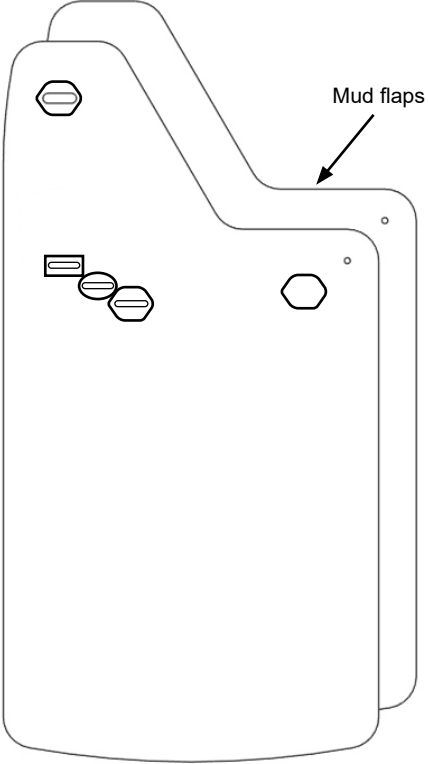
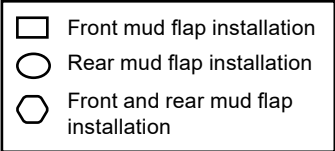

NOTE: Hardware components and appearance may vary.

▲ CAUTION: Ensure all mounting hole sides are free of wiring, mechanical parts and are structurally sound.

PARTS DIAGRAM

NOTE: Mud flaps may be purchased with or without pre-installed trim plates (not pictured). Trim plates are also available for purchase as an accessory.



-  Nylon hex nuts
-  Serrated flange nuts
-  5/16" x 1" Allen button head bolts
-  #10 x 1-1/4" Self-drilling hex screws
-  #10 x 1-1/2" Truss head screws
-  7 mm Screws

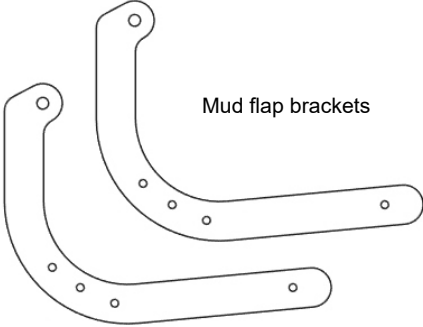
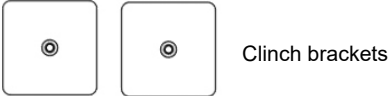

1: PREPARING FOR INSTALLATION

A. Park on level ground with firm surface.

B. Check free space behind front tires when fully turned. Ensure enough space and clearance to accommodate 5/16" thick mud flaps.

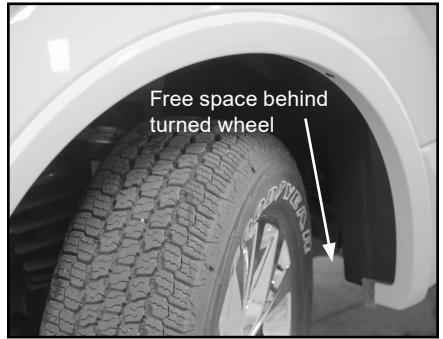

NOTE: If trim plates are pre-installed, face them toward tailgate during installation.

C. To install mud flaps, perform one of the following:

- See Step 2 for front wheel well installation
- See Step 3 (page 6) for rear wheel well installation

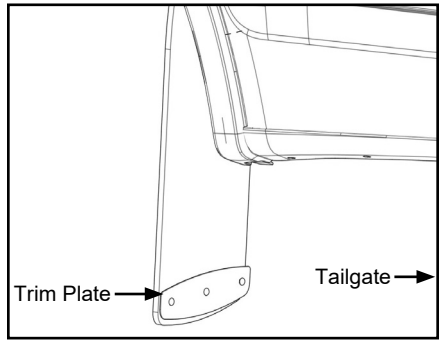

2: INSTALLING MUD FLAPS TO FRONT

NOTE: Front mud flap installation uses mud flap bracket, clinch bracket and 4 mounting holes per mud flap, see PARTS DIAGRAM (page 3) for locations.

A. Use 7 mm socket to remove lower factory mounting hardware indicated in adjacent image.

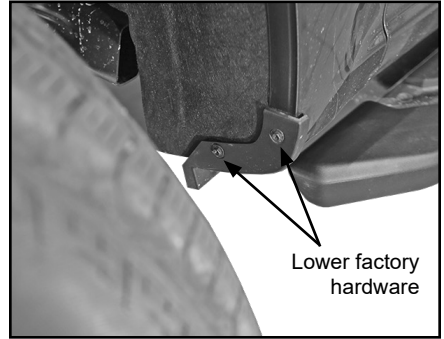

B. Align mud flap bracket holes with holes on mud flap. Then install with (2) 7mm screws through 2nd and 4th holes into newly free holes in wheel well. Use 7mm socket to start screw into mud flap.

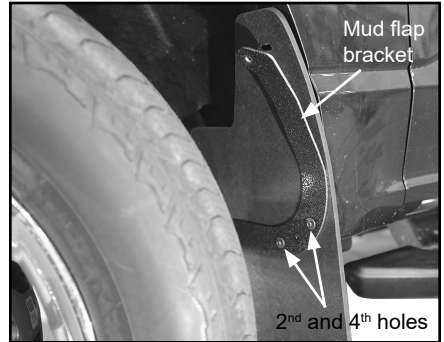

C. Install 5/16" x 1" Allen button head bolt through 1st hole in mud flap bracket, then mud flap. Holding bracket in place, insert clinch bracket behind mud flap and install onto 5/16" x 1" Allen button head bolt. Ensure clinch bracket is behind lip on wheel well with extended threads facing away from mud flap. Push clinch bracket as far behind lip as it can go. Leave bolt loose for now.

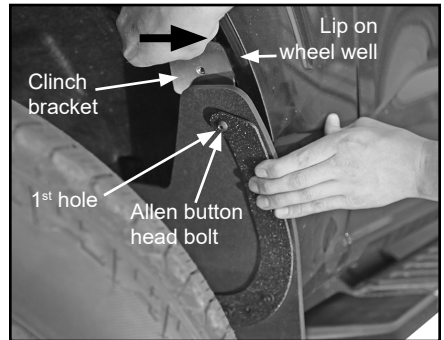

D. Level mud flap while adjusting placement to obtain best fit. Starting with screws, tighten all hardware to hold in place.

E. Use mud flap bracket's inner most hole as a guide to install a #10 x 1-1/4" self-drilling hex screw and secure with nylon hex nut.

Tip: If mud flap bracket's inner most hole is difficult to reach, turn wheel in opposite direction.

F. Repeat for remaining front mud flap.

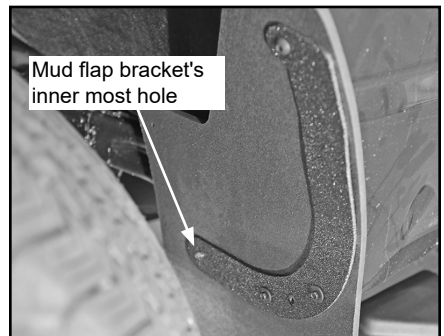

3: REAR MUD FLAP INSTALLATION

NOTE: Rear mud flap installation uses mud flap bracket, clinch bracket and 4 mounting holes per mud flap, see PARTS DIAGRAM (page 3) for locations.

A. Remove bottom inner factory mounting hardware from wheel well lip.

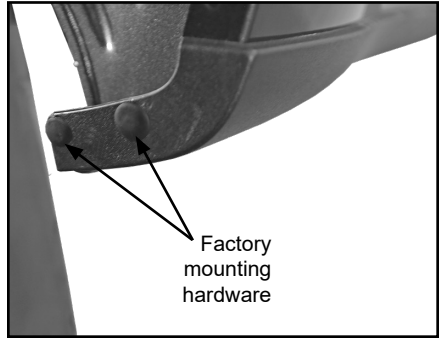

B. Align mud flap bracket holes with holes on mud flap. Then install with (2) #10 x 1-1/2" truss head screws through 2nd and 3rd holes into free holes in wheel well. Secure with serrated flange nut and finger tighten.

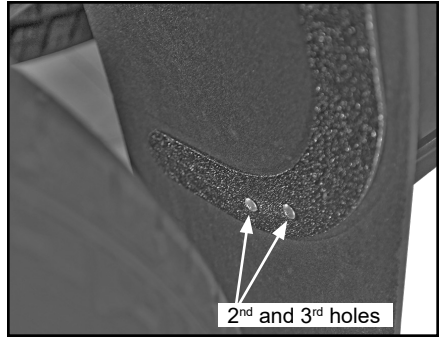

C. Install 5/16" x 1" Allen button head bolt through 1st hole in mud flap bracket, then mud flap. Holding bracket in place, insert clinch bracket behind mud flap and install onto 5/16" x 1" Allen button head bolt. Ensure clinch bracket is behind lip on wheel well with extended threads facing away from mud flap. Push clinch bracket as far behind lip as it can go. Leave bolt loose for now.

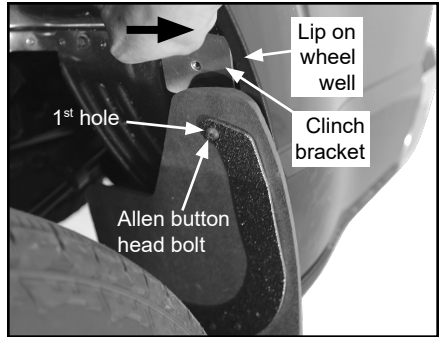

D. Level mud flap while adjusting placement to obtain best fit. Starting with screws, tighten all hardware to hold in place.

E. Use mud flap bracket's inner most hole as a guide to install a #10 x 1-1/4" self-drilling hex screw and secure with nylon hex nut.

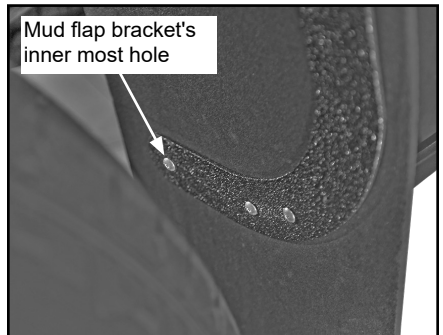

F. Repeat for remaining rear mud flap.

SAFETY AND MAINTENANCE

The operator can perform most of inspection and maintenance. It may be necessary to review the installation instructions.

- Periodically check all screws, washers and nuts, retighten if needed.
- If mud flap has been damaged, replace with new one.

NOTE: Inspection and/or maintenance should be performed anytime a malfunction is observed or suspected. If you need assistance inspecting and/or servicing your mud flaps, call customer service at 888-568-3709. Always use original equipment replacement parts for your mud flaps.

MANUFACTURER'S LIMITED WARRANTY

Agri-Cover, Inc. extends the following (1) year Limited Warranty for the ROCKSTAR™ Splash Guard Mud Flaps:

Agri-Cover, Inc. warrants a period of one (1) year from the date of manufacture that its ROCKSTAR™ Splash Guard Mud Flaps are free from defects in workmanship, under normal use for the truck model it was intended for. This Limited Warranty does not cover any damage due to accident, abuse, misuse, alteration, neglect, improper installation, or ordinary wear and tear.

Agri-Cover, Inc.'s sole obligation under this Limited Warranty is limited to the repair or replacement at its option, of defective parts only. No labor or service allowance is given or implied. IN NO EVENT SHALL AGRI-COVER, INC. BE LIABLE FOR INCIDENTAL, CONSEQUENTIAL, OR SPECIAL DAMAGES. AGRI-COVER, INC. EXPRESSLY DISCLAIMS ANY AND ALL IMPLIED WARRANTIES OF MERCHANTABILITY, AND THERE ARE NO WARRANTIES WHICH EXTEND BEYOND THE LIMITED WARRANTY DESCRIPTION CONTAINED HEREIN.

For warranty, fill out the warranty claim form at agricover.com/warrantyclaim or call Customer Service Department at 888-568-3709 to determine if only a replacement part is needed or if the mud flaps needs to be returned for inspection and repair. Goods to be returned must have a pre-authorized RA # (Return Authorization Number) - obtained by calling the number above. Mark the number on the package and ship it freight prepaid to address below. Agri-Cover, Inc. will pay freight to return goods to sender.

This Limited Warranty gives you specific legal rights and you may have other rights, which vary, from state to state.

For replacement parts shop at rockstarmudflaps.com or call Customer Service at 888-568-3709.



Agri-Cover, Inc.
Customer Service Dept
3000 Hwy 281 SE
Jamestown, ND 58401
Phone: 888-568-3709

Hours: 8:00 am - 5:00 pm CST Monday through Friday, except Holidays